



## Burner Controls

**LOK16...**  
**LGK16...**

### Burner controls

- For gas, oil or dual-fuel forced draft burners of medium to high capacity
- With self-checking flame signal amplifier
- For continuously operating multistage or modulating oil or gas burners of medium to high capacity
- With air pressure supervision for checked air damper control.
- Burner control for oil burners to EN 230: 2005

The LOK16.../LGK16... and this Data Sheet are intended for use by OEMs which integrate the burner controls in their products.

Burner controls type LOK16.../LGK16... feature a self-checking flame supervision circuit.

The supervision circuit initiates the required safety actions not only in the case of premature or missing flame signals, but also in the event of any kind of fault on the flame detector, the detector cables or the flame signal amplifier that could simulate a flame signal during burner operation.

The burner controls are therefore suited for use in all types of oil- or gas-fired combustion plant where self-checking flame supervision systems are either mandatory or recommended.

For example:

- Burners that operate continuously
- Burners in intermittent operation that, in the case of great heat demand, may operate continuously for more than 14 hours, e.g. in plant using boiler sequencing
- Burners that need to comply with the German TRD 411 and TRD 412 regulations for steam boilers
- Burners in plant where, for specific safety requirements, supervision of the burner by a self-checking flame supervision system seems advisable
- The control sequence and connection circuitry of the LOK16.../LGK16... burner controls are identical to those of the LAL2... and LFL1... respectively (with the exception of the LFL1.148), so that existing combustion plant can also be equipped with self-checking burner controls,
  - provided very good flame detector current values are measured in the plant supervised so far by the LFL1..., and
  - provided the following types of flame detectors are either installed or can subsequently be fitted:

Flame supervision when using LOK16...

- Silicon photocell detector RAR9...

Flame supervision when using LGK16...

- Flame detector QRA53.../QRA55...
- Ionization probe
- Flame detector QRA53.../QRA55... together with ionization probe, e.g. in the case of burners using a pilot burner (also see Data Sheet N7712)

## Warning notes

---



**To avoid injury to persons, damage to property or the environment, the following warning notes must be observed!**

### **Do not open, interfere with or modify the unit!**

- All activities (mounting, installation and service work, etc.) must be performed by qualified staff
- Before making any wiring changes in the connection area, completely isolate the plant from mains supply (all-polar disconnection). Ensure that the plant cannot be inadvertently switched on again and that it is indeed dead. If not observed, there is a risk of electric shock hazard
- Ensure protection against electric shock hazard by providing adequate protection for the burner control's connection terminals
- Each time work has been carried out (mounting, installation, service work, etc.), check to ensure that wiring is in an orderly state and make the safety checks as described in *Commissioning notes*
- Press the lockout reset button only manually (applying a force of no more than 10 N) without using any tools or pointed objects
- **Do not press the lockout reset button on the unit or the remote reset button (input 21) for more than 10 seconds, since this would damage the lockout relay inside the unit**
- Fall or shock can adversely affect the safety functions. Such units must not be put into operation, even if they do not exhibit any damage

## Mounting notes

---

Ensure that the relevant national safety regulations are complied with.

### Upgrading existing plant

When converting plant to LOK16... or LGK16..., the existing LAL... or LFL... base must be secured by a cylinder-shaped grooved pin, thus ensuring that only an LOK16... or LGK16... type burner control can be fitted.

Part number of grooved pin: 4 166 8024 0

Location of grooved pin:

Between terminals 10 and 11 of the LAL... base, and between terminals 4 and 5 of the LFL... base.

### Start repetition in the event of loss of flame

By removing link (B) on the underside of the unit, the LOK16... can be switched to start repetition in the event of loss of flame during operation.

In that case, the wire link must be cut off completely.

However, it must be checked whether this is in compliance with national standards and regulations.

## Installation notes

---

- Always run the high-voltage ignition cables separately while observing the greatest possible distance to the unit and to other cables
- Neutral conductors must not be interchanged
- Install switches, fuses, earthing, etc., in compliance with local regulations
- Make certain that the maximum permissible current rating of the connection terminals will not be exceeded

## Electrical connection of flame detectors

It is important to achieve practically disturbance- and loss-free signal transmission:

- Never run the detector cable together with other cables
  - Line capacitance reduces the magnitude of the flame signal
  - Use a separate cable
- Observe the permissible detector cable lengths (see Technical data)
- It is not permitted to connect 2 flame detectors QRA53.../QRA55... in parallel
- When using the QRA53.../QRA55..., earthing of terminal 22 is mandatory
- The ionization probe is not protected against electric shock hazard
- Locate the ignition electrode and ionization probe such that the ignition spark cannot arc over to the ionization probe (risk of electrical overloads) and that it cannot adversely affect the supervision of ionization
- Supervision with ionization probe and QRA... flame detector is possible but, for safety reasons, both must not be active at the same time, with the exception of the second safety time (t9). At the end of the second safety time, one of the detected flames must extinguish, e.g. by shutting down the pilot gas valve connected to terminal 17

## Commissioning notes

- When commissioning the plant or when doing maintenance work, make the following safety checks:

	<b>Safety check to be carried out</b>	<b>Anticipated response</b>
a)	Burner startup with flame detector darkened	Lockout at the end of safety time
b)	Burner startup with simulated flame	Lockout after no more than 40 seconds
c)	Burner operation with simulated loss of flame; for that purpose, darken the flame detector in operation and leave it in that state	<b>LOK16...</b> with wire link cut: Start repetition followed by lockout at the end of safety time <b>LGK16...</b> and <b>LOK16...</b> with wire link closed: Immediate lockout
d)	Burner startup with response of air pressure switch	Prevention of startup/lockout during prepurge time
e)	Burner operation with simulated air pressure failure	Immediate lockout

## Standards and certificates



Conformity to EEC directives

- Electromagnetic compatibility EMC (immunity)
- Low-voltage directive
- Directive for gas appliances
- Directive for pressure devices

2004/108/EC  
2006/95/EC  
2009/142/EC  
97/23/EC



ISO 9001: 2010  
Cert. 00739



ISO 14001: 2010  
Cert. 38233

**Identification code to EN 230/EN 298 F B/M L L X K**

*Certified with plug-in base and flame detector:*

Type reference								
LOK16.140...	---	---	●	●	●	●	●	---
LOK16.250...	---	---	●	●	●	●	●	---
LOK16.650...	---	---	●	●	●	●	●	---
LGK16.122...	●	●	●	---	---	---	●	●
LGK16.133A17	---	●	---	---	---	---	●	●
LGK16.133A27	●	●	●	---	---	---	●	●
LGK16.322...	●	●	●	---	---	---	●	●
LGK16.333...	●	●	●	---	---	---	●	●
LGK16.335...	●	●	●	---	---	---	●	●
LGK16.622...	●	●	●	---	---	---	●	●
LGK16.635...	●	●	●	---	---	---	●	●

## Service notes

- The KF8832 flame detector current measuring device must not be used in continuous operation

## Life cycle

Burner controls has a designed lifetime\* of 250,000 burner startup cycles which, under normal operating conditions in heating mode, correspond to approx. 10 years of usage (starting from the production date given on the type field). This lifetime is based on the endurance tests specified in standard EN 230/EN 298 and the table containing the relevant test documentation as published by the European Association of Component Manufacturers (Afecor) ([www.afecor.org](http://www.afecor.org)).

The designed lifetime is based on use of the burner controls according to the manufacturer's Data Sheet. After reaching the designed lifetime in terms of the number of burner startup cycles, or the respective time of usage, the burner control is to be replaced by authorized personnel.

\* The designed lifetime is not the warranty time specified in the Terms of Delivery

## Disposal notes



The unit contains electrical and electronic components and must not be disposed of together with household waste.  
Local and currently valid legislation must be observed.

## Mechanical design

---

LGK16.../LOK16...

- Plug-in design
- Exchangeable unit fuse (including spare fuse)

Housing

- Made of impact-proof and heat-resistant black plastic
- Lockout reset button with viewing window; located behind it are:
  - The lockout warning lamp
  - The lockout indicator
    - coupled to the spindle of the sequence switch
    - visible in the transparent lockout reset button
    - uses easy-to-remember symbols to indicate the type of fault and the point in time lockout occurred

## Type summary

Switching times are given in the order of the startup sequence, valid for 50 Hz mains frequency. At 60 Hz, the times are about 20% shorter. The type references apply to burner controls operating on AC 230 V, 50...60 Hz.

\* For burner controls operating on AC 100...110 V, 50...60 Hz, the last 2 digits of the type reference read «17» in place of «27».

### LOK16...

For flame supervision with a silicon photocell detector RAR9... for oil burners				Legend of times
Preferred use:				
Flash-steam generators	Universal application	Medium- or heavy-oil burners		
LOK16.140A27*	LOK16.250A27*	LOK16.650A27		
t1	10 s	22 s	66 s	Prepurge time with air damper fully open
TSA	4 s	5 s	5 s	Safety time or first safety time with burners using a pilot burner
TSA'	---	---	---	Safety time or first safety time with burners using a pilot burner
t3	2 s	2.5 s	2.5 s	Preignition time
t3'	From startup command (with air pressure supervision: from receipt of air pressure signal)			Long preignition time
t3n	10 s	15 s	15 s	Postignition time (ignition transformer connected to terminal 15)
t4	8 s	7.5 s	7.5 s	Interval between start of safety time and release of valve at terminal 19
t4'	---	---	---	Interval between start of safety time and release of valve at terminal 19
t5	4 s	7.5 s	7.5 s	Interval between end of interval (t4/t4') and release of load controller or valve at terminal 20
t6	10 s	15 s	15 s	Postpurge time (identical to permissible afterburn time (t13))
t7	2 s	2.5 s	2.5 s	Switch-on delay of fan motor (M2)
t8	30 s	47 s	91 s	Duration of startup without «t11» and «t12»
t9	---	---	---	Second safety time with burners using a pilot burner
t10	6 s	10 s	10 s	Interval from startup to the beginning of the air pressure check
t11	Optional			Air damper running time to the fully open position
t12	Optional			Air damper running time to the low-fire position
t13	10 s	15 s	15 s	Permissible afterburn time
t16	4 s	5 s	5 s	Interval from startup to the open command for the air damper
t20	32 s	34.5 s	12.5 s	Interval to self-shutdown of the sequence switch

### LGK16...

For flame supervision with flame detector QRA53.../QRA55... or ionization probe							
	Preferred use:			D, A	GB	F, I	B, NL
	Flash-steam generators	Flash-steam generators	D (also suited for direct-fired air heaters), F				
	LGK16.122A27*	LGK16.133A27	LGK16.322A27*	LGK16.333A27*	LGK16.335A27*	LGK16.622A27*	LGK16.635A27*
t1	10 s	9 s	35.5 s	31.5 s	37 s	65 s	66 s
TSA	2 s	3 s	2 s	3 s	2.5 s	2 s	2.5 s
TSA'	2 s	3 s	2 s	3 s	5 s	2 s	5 s
t3	4 s	3 s	4 s	6 s	5 s	4 s	5 s
t3'	4 s	---	4 s	6 s	2.5 s	4 s	2.5 s
t3n	---	---	---	---	---	---	---
t4	6 s	6 s	10 s	11.5 s	12.5 s	10 s	12.5 s
t4'	6 s	---	10 s	11.5 s	15 s	10 s	15 s
t5	4 s	3 s	10 s	11.5 s	12.5 s	10 s	12.5 s
t6	10 s	14.5 s	12 s	17 s	15 s	12 s	15 s
t7	2 s	3 s	2 s	3 s	2.5 s	2 s	2.5 s
t8	30 s	29 s	65 s	69 s	74 s	95 s	103 s
t9	2 s	3 s	2 s	3 s	5 s	2 s	5 s
t10	6 s	6 s	8 s	11.5 s	10 s	8 s	10 s
t11	Optional						
t12	Optional						
t13	10 s	14.5 s	12 s	17 s	15 s	12 s	15 s
t16	4 s	3 s	4 s	6 s	5 s	4 s	5 s
t20	32 s	60 s	---	26 s	22 s	---	---

## Ordering

### Oil burner controls, without plug-in base

(plug-in base not included in delivery, must be ordered as a separate item)

For AC 230 V*	Control sequence and connection diagram like	Preferred use
<b>LOK16.140A27*</b>	LAL2.14	Flash-steam generators
<b>LOK16.250A27*</b>	LAL2.25	Universal application
<b>LOK16.650A27</b>	LAL2.65	Heavy-oil burners

\* For burner controls operating on AC 100...110 V, 50...60 Hz, the last 2 digits of the type reference read «17» in place of «27»

### Connection accessories for medium-capacity burner controls see Data Sheet N7230

- Plug-in base **AGM16** with Pg11 thread for cable entry glands
- Plug-in base **AGM16.1** with M16 thread for cable entry glands

### Flame detectors

- Silicon photocell detectors **RAR9...** see Data Sheet N7713

### Gas burner controls, without plug-in base

(plug-in base not included in delivery, must be ordered as a separate item)

For AC 230 V*	Control sequence and connection diagram like	Preferred use
<b>LGK16.122A27*</b>	LFL1.122	Flash-steam generators
<b>LGK16.133A27</b>	LFL1.133	Flash-steam generators
<b>LGK16.322A27*</b>	LFL1.322	D (also suited for direct-fired air heaters), F
<b>LGK16.333A27*</b>	LFL1.333	D, A
<b>LGK16.335A27*</b>	LFL1.335	GB
<b>LGK16.622A27*</b>	LFL1.622	I, F
<b>LGK16.635A27*</b>	LFL1.635	B, NL

\* For burner controls operating on AC 100...110 V, 50...60 Hz, the last 2 digits of the type reference read «17» in place of «27»

### Connection accessories for medium-capacity burner controls see Data Sheet N7230

- Plug-in base **AGM17** with Pg11 thread for cable entry glands
- Plug-in base **AGM17.1** with M16 thread for cable entry glands

### Flame detectors

- Flame detectors **QRA53.../QRA55...** see Data Sheet N7712
- **ionization probe** to be supplied by thirds



### Flame detector current measuring device

**KF8832**

- For detector current measurements with QRA53..., QRA55... , recommended up to series C and E
- Not suited for continuous operation
- Only for measurements of short duration
- The KF8832 negates the self-supervision function



## Technical data

General unit data LOK16.../LGK16...	Mains voltage	AC 220 V -15%...AC 240 V +10% AC 100 V -15%...AC 110 V +10%	
	Mains frequency	50...60 Hz $\pm 6\%$	
	Unit fuse	T6,3H250V to DIN EN 60 127	
	Primary fuse (external)	Max. 16 A (slow)	
	Weight	Approx. 1000 g	
	Power consumption	Approx. 3.5 VA	
	Perm. mounting position	Optional	
	Degree of protection	IP40, (to be ensured through mounting) with the exception of the connection area (terminal base)	
	Safety class	II	
	Perm. input current at terminal 1	Max. 5 A to VDE 0660 AC3	
	Perm. current load of control terminals	Max. 4 A to VDE 0660 AC3	
	Required switching capacity of switching devices		
	- Between terminals 4 and 5, 4 and 12	1 A, AC 250 V	
	- Between terminals 4 and 14	depending on loading of terminals 15, 16, 18, 19 (LGK16...: 16...19), min. 1 A, AC 250 V	
	Environmental conditions	<b>Storage</b>	DIN EN 60721-3-1
		Climatic conditions	Class 1K3
		Mechanical conditions	Class 1M2
Temperature range		-20...+60 °C	
Humidity		<95% r.h.	
<b>Transport</b>		DIN EN 60721-3-2	
Climatic conditions		Class 2K3	
Mechanical conditions		Class 2M2	
Temperature range		-20...+60 °C	
Humidity		<95% r.h.	
<b>Operation</b>		DIN EN 60721-3-3	
Climatic conditions		Class 3K3	
Mechanical conditions	Class 3M3		
Temperature range	-20...+60 °C		
Humidity	<95% r.h.		



### Caution!

Condensation, formation of ice and ingress of water are not permitted!

Flame supervision

	LOK16...	LGK16...		
	RAR9...	QRA5x.C... QRA5x.E...	QRA5x.D... QRA5x.G...	Ionization probe
Operating voltage (Terminal 23 or 24)	<DC 1 V ±10%	AC 280 V <sup>1)</sup> ±10%	AC 280 V <sup>1)</sup> ±10%	AC 245 V <sup>1)</sup> ±10%
Minimum detector current required	DC 6 µA	DC 35 µA	DC 120 µA	DC 12 µA
Maximum possible detector current	DC 38 µA	DC 50 µA	DC 270 µA	DC 100 µA
Short-circuit current	---	---	---	Approx. AC 300 µA
Maximum length of detector cable (laid separately)	100 m	<sup>2)</sup>	<sup>2)</sup>	60 m <sup>3)</sup>

- 1) AC voltage, measured with no detector current at AC 230 V mains voltage. Internal resistance of measuring instrument 10 MΩ. The shutter of the flame detector QRA53.../QRA55... is powered by mains voltage
- 2)
  - Detector cable laid in a minimum distance of 5 cm from other mains carrying cable:
    - As a multiple cable **Max. 50 m**
    - With 5 single wires **Max. 70 m**
  - With a shielded 3-core control cable to terminals 3, 4 and 5 of the flame detector QRA53.../QRA55... and standard mains cable to terminals 1 and 2 **Max. 15 m**
  - With 2 shielded single-core coaxial cables (≤45 pF/m, e.g. RG 62) to terminals 3 and 4 of the flame detector QRA53.../QRA55... and standard mains cable to terminals 1, 2 and 5 **Max. 60 m**
  - If possible, shielding should be earthed at both ends
- 3) Longer cable distances are permitted when connecting low-capacitance detector cables to terminal 24 of the burner control (especially against earthed wires!)

## Detector current measurement

LOK16.../RAR9...

The measuring device must be connected between the detector and terminal 22 (+pole to terminal 22).

With RAR9...

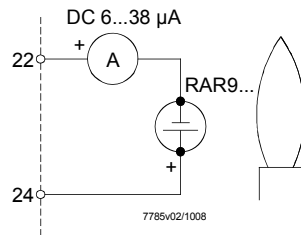

LGK16.../QRA53.../  
QRA55...

Use the KF8832 measuring device (not suited for continuous operation).  
There is no self-checking while measurements are made.  
The KF8832 is not required when using the QRA5x.D.../QRA5x.G...

With QRA5x.C.../QRA5x.E...

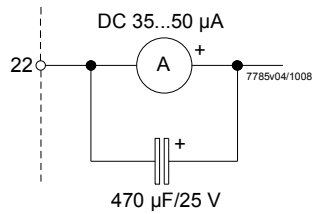

With QRA5x.D.../QRA5x.G...

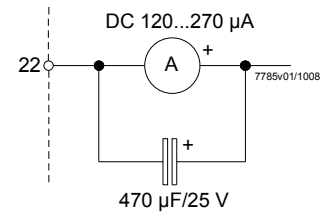

## Detector current measurement (cont'd))

LGK16.../ionization  
probe

The measuring device must be connected between terminal 24 and the detector electrode (+pole to terminal 24).

With ionization

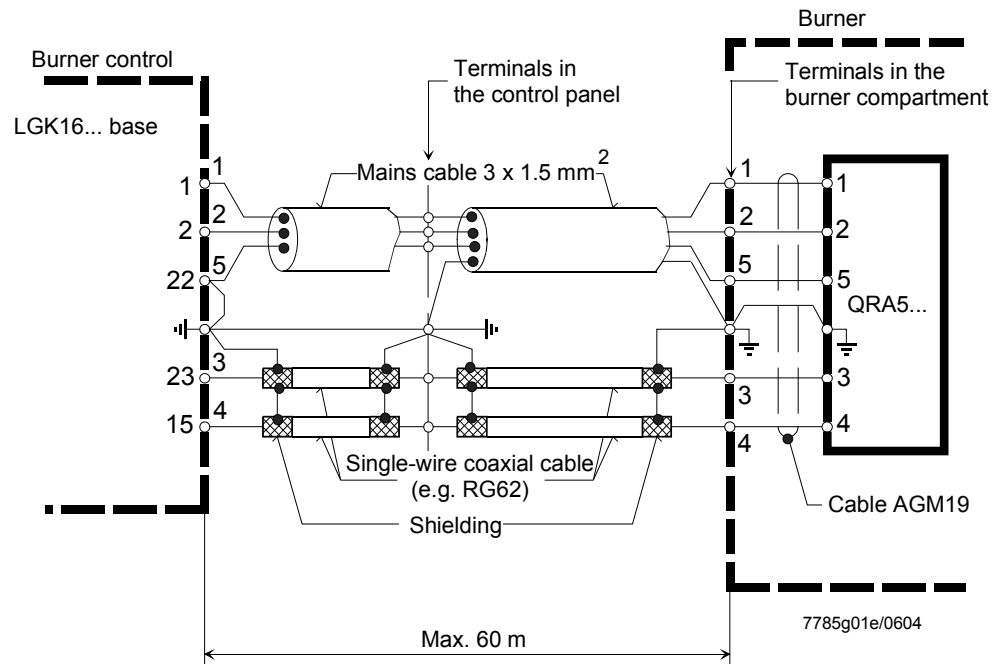
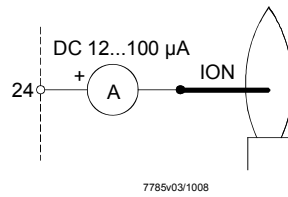

Legend

A Ammeter  
RAR9... Silicon photocell detector  
ION Ionization probe

## Function

### Principle of self-supervision

In contrast to conventional amplifiers, the signal delivered by the flame detector is handled dynamically and not statically. The flame detector signal is converted to a sequence of control pulses and then fed to the flame relay circuit. The latter is designed such that the flame relay can only be energized by a flame signal of the described form. If the pulses change due to a faulty detector or faulty detector cables, the relay will be deenergized and the burner control triggers the required safety actions. In the case of UV supervision, it must also be ensured that self-ignition of the UV tube (e.g. due to aging) does not simulate a flame signal. For that reason, incident radiation at the UV cell is periodically interrupted by a shutter. In addition to the self-checking facility, the flame signal circuit is subjected to a functional test during the prepurge time. If it does not operate correctly, the startup sequence will be aborted or lockout initiated. Furthermore, if mains voltage drops to a level where safe operation of the burner control is no longer ensured, the burner will automatically shut down. When mains voltage returns to the normal level, the burner control repeats the startup sequence. If the detector signals are only slightly above the minimum levels, such mains voltage fluctuations can also give rise to burner lockout however.

### Prerequisites for burner startup

- The burner control is reset and in the start position (terminals 11 and 12 must receive power)
- The air damper is closed. End switch (z) for the fully closed position must feed power from terminal 11 to terminal 8
- All control contacts between terminals 12 and 5 (limit thermostat, control thermostat, etc.) must be closed

#### A Start

When control thermostat or pressurestat closes, the burner control's sequence switch starts running. At the same time, the fan motor connected to terminal 6 (only prepurging) receives power and, on completion of switch-on delay time, the fan motor or flue gas fan at terminal 7 (pre- and postpurging) also receives power. On completion of interval (t16), the control command to open the air damper is given via terminal 9. During the running time of the motor, the sequence switch does not operate, as terminal 8, via which the motor of the sequence switch first receives power, is not live during that period of time. The sequence switch starts again and programs only after the air damper is fully open and end switch (a) has changed over to feed power to terminal 8.

**t1 Prepurge time** with air damper fully open (nominal amount of combustion air)  
Shortly after the start of the prepurge time, air pressure switch must change over, thus interrupting the current path between terminals 4 and 13. Otherwise, the burner control would go to lockout (start of air pressure check). At the same time, terminal 14 must be live since this current path is used to power the ignition transformer and the fuel valves.

**t3** With the LOK16..., an ignition transformer connected to terminal 15 is therefore switched on at this point in time (long preignition). If there is no air pressure switch, the ignition transformer receives power already with the start command. On completion of the prepurge time, the burner control via terminal 10 drives the air damper into the low-fire position, which is determined by the changeover point of auxiliary switch (m). During the positioning time, the sequence switch stops again until terminal 8 receives power from «m».

#### t5 Interval

On completion of interval (t5), terminal 20 receives power. At the same time, control outputs 9 to 11 and input 8 are galvanically separated from the unit's control section, so that the latter is protected against reverse voltages from the load control circuit. The startup sequence of the burner control ends with the release of load controller at terminal 20. The sequence switch switches itself automatically off, depending on the time variant used, either immediately or after some so-called *idle steps*, that is, without changing the contact positions.

## Function (cont'd)

Expanding flame burners with LOK16... or LGK16...

**t3 Short preignition time**; followed by fuel release via terminal 18.

**TSA Safety time** (part load)

On completion of the safety time latest, a flame signal must be present at the input of the flame signal amplifier, or else the burner control will initiate lockout.

**Only with LOK16...:**

**t3n Postignition time** (provided the ignition transformer is connected to terminal 15).

**t4 Interval** until the fuel valve is released via terminal 19.

Interrupted pilot burner with LGK16...

(Burners using a pilot burner)

**t3/t3' Short preignition time**; followed by release of fuel for the pilot burner via terminal 17.

**TSA/TSA' First safety time** (ignition load)

On completion of the safety time latest, a flame signal must be present at the input of the flame signal amplifier, or else the burner control will initiate lockout.

**t4/t4' Interval** until the fuel valve at terminal 19 is released (start load of the main burner). Times safety time (TSA'), short preignition time (t3') and interval (t4') are only programmed by burner controls type **LGK16.335...** and **LGK16.635...**

**t9 Second safety time**

On completion of the safety time, the main burner must have been ignited by the pilot burner, since the pilot gas valve is closed on completion of second safety time (t9).

**B Operating position of the burner**

**B-C Burner operation** (generation of heat)

During burner operation, the load controller drives the air damper to the nominal load or low-fire position, depending on heat demand. Here, the nominal load is released by auxiliary switch (v) in the actuator.

**C Controlled shutdown by control thermostat or pressurestat**

In the case of controlled shutdown, the fuel valves are immediately closed and, at the same time, the sequence switch starts again to program the postpurge time (t6).

**t6 Postpurge time** (postpurging with fan (M2) connected to terminal 7).

Shortly after the start of the postpurge time, voltage at terminal 10 is reinstated, so that the air damper is driven into the MIN position. The full closing of the air damper starts only shortly before the completion of the postpurge time initiated by the control signal on terminal 11, which also remains live during the following burner off period.

**t13 Permissible afterburn time**

During permissible afterburn time (t13), the flame signal input may still receive a flame signal

→ No lockout

**D-A End of control sequence** (= start position)

When, on completion of postpurge time (t6), the sequence switch has reset the control contacts to their start positions, thereby switching itself off, the detector and flame simulation test is started again. However, during the burner off period, lockout can occur only if the faulty flame signal lasts a few seconds. Hence, short ignition pulses of the UV detector caused by cosmic radiation do not initiate lockout.

## Control sequence in the event of fault and indication of lockout

---

In case of any disturbance, the supply of fuel will immediately be interrupted. At the same time, the sequence switch stops and thus the lockout indicator also.

The symbol appearing above the reading mark indicates the kind of fault:

- ◀ No start, because one of the contacts is not closed (also see *Prerequisites for burner startup*) or lockout during or after completion of the control sequence due to extraneous light (e.g. flame not extinguished, leaking fuel valves, faulty flame supervision circuit, or similar).
- ▲ Abortion of startup sequence, because end switch (a) has not fed the OPEN signal to terminal 8. Terminals 6, 7 and 14 and, in case **LOK16...** is used, terminal 15, also remain live until the fault is corrected.
- P Lockout, because the air pressure signal has not been received at the start of the air pressure check. Each air pressure failure after this time initiate also lockout.
- Lockout due to a fault in the flame supervision circuit.
- ▼ Abortion of startup sequence, because auxiliary switch (m) has not delivered the positioning signal for the low-fire position to terminal 8. Terminals 6, 7 and 14 and, in case **LOK16...** is used, terminal 15, also remain live until the fault is corrected.
- 1 Lockout, because no flame signal has been received on completion of the (first) safety time.
- 2 **Only with LGK16...:**  
Lockout, because no flame signal has been received on completion of the second safety time (flame signal of the main flame with interrupted pilot burners).
- I Lockout, because the flame signal has been lost during burner operation or air pressure failure has occurred.

### **Only with LOK16...:**

If wire link (B) was cut off and the flame is lost during burner operation, the burner control programs a repetition of the startup sequence with the full program.

Lockout indication

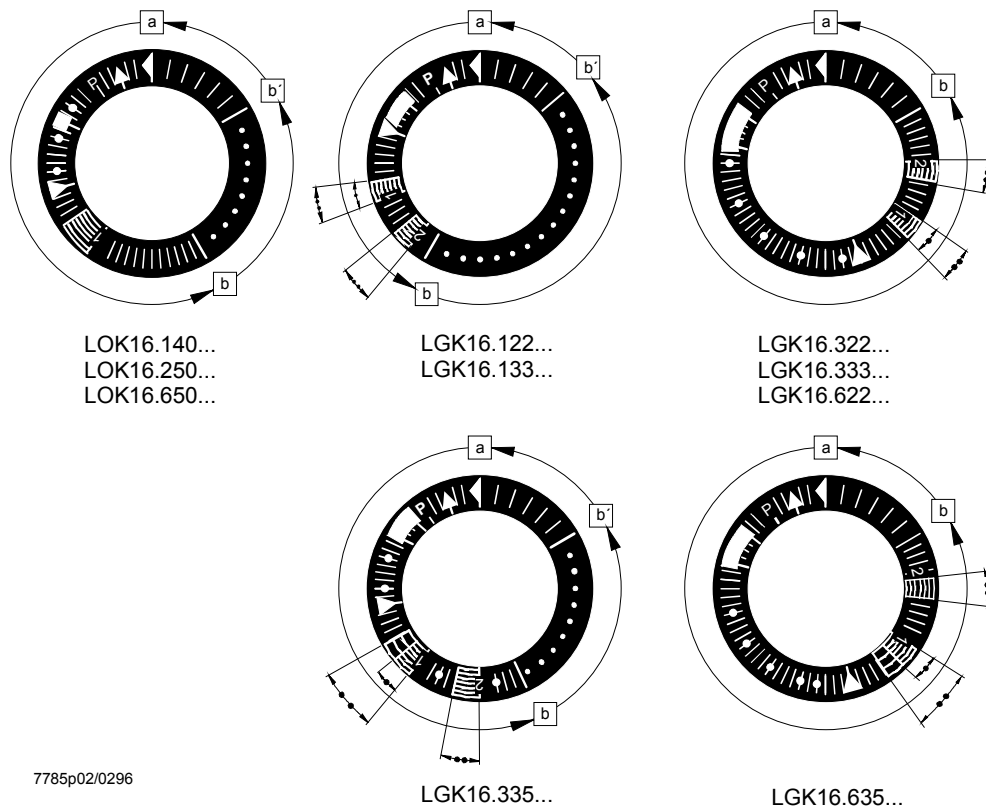

a-b Startup sequence

b-b' With certain time variants:  
*Idle steps* of the sequence switch up to the self-shutdown after burner startup  
 (b' = operating position of the sequence switch)

b(b')-a Postpurge sequence after controlled shutdown.  
 In start position (a), the sequence switch switches itself automatically off or immediately initiates another burner startup (e.g. after a fault has been corrected)

- Duration of safety time with expanding flame burners
- Duration of safety times with interrupted pilot burners

When lockout has occurred, the burner control can immediately be reset. After resetting, and also after correction of a fault, which resulted in shutdown, or after a mains failure, the sequence switch always runs to its start position, whereby only terminals 7, 9, 10 and 11 receive power in accordance with the control sequence. It is only then that the burner control programs a burner restart.

**Note!**  
**Do not press the lockout reset button for more than 10 seconds.**



Connection diagrams (for circuitry variants, see *Connection examples*)

LOK16...

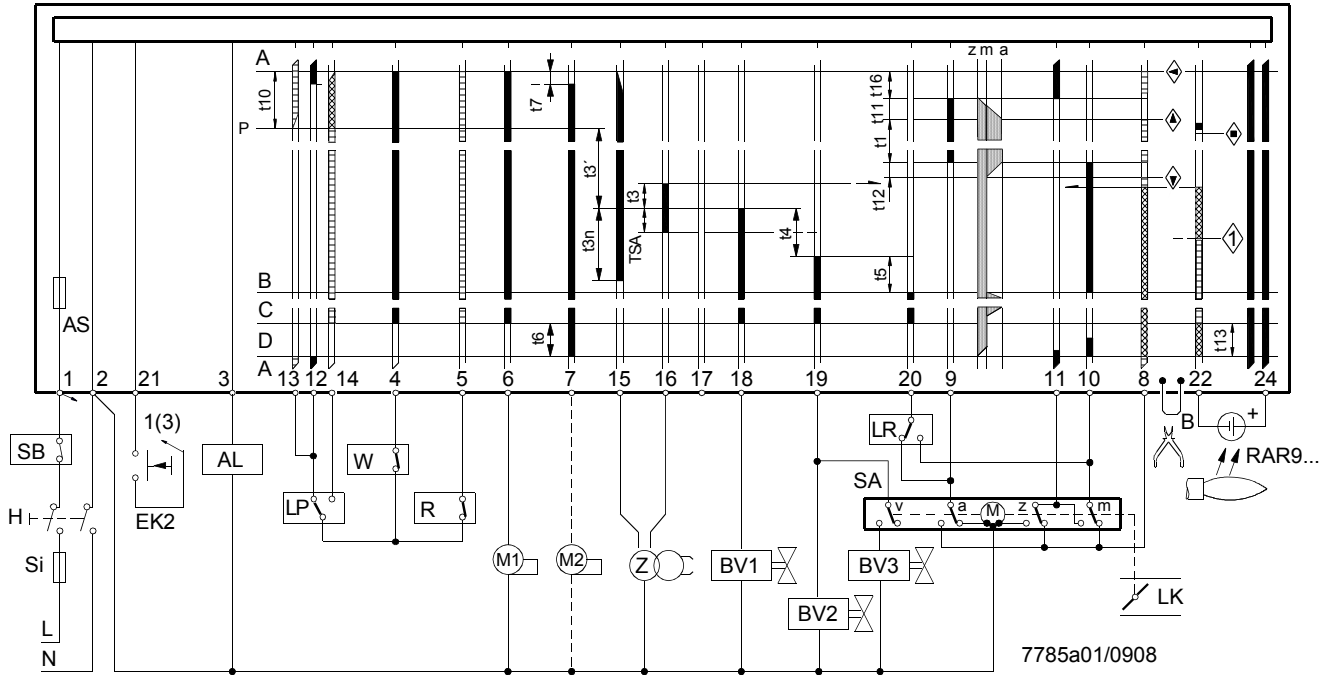

**Caution!**  
Do not press lockout reset button (EK...) for more than 10 seconds!

LGK16...

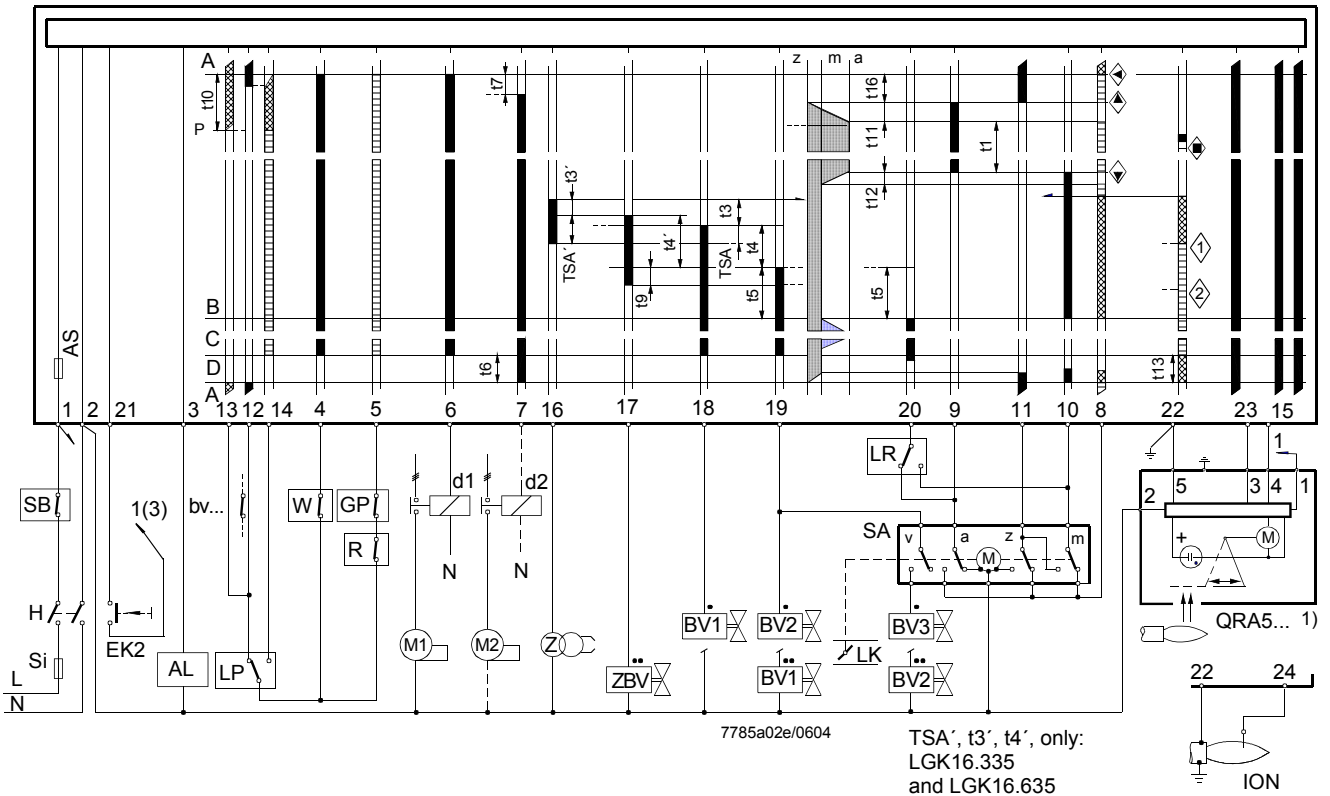



**Caution!**  
Do not press lockout reset button (EK...) for more than 10 seconds!

1) When used in connection with QRA53.../QRA55..., earthing of terminal 22 is mandatory!

## Legend

---

a	Changeover end switch for air damper's fully open position
AL	Remote lockout warning device (alarm)
AR	Main relay (load relay) with «ar» contacts
AS	Unit fuse
B	Wire link (on the burner control's base)
BR	Lockout relay with «br» contacts
BV...	Fuel valve
bv...	Auxiliary contact in the valve actuator for the fully closed position check
d...	Contact or relay
EK...	Lockout reset button
ION	Ionization probe
FR	Flame relay with «fr» contacts
FS	Flame signal
GP	Gas pressure switch
H	Mains isolator
L...	Lockout warning lamp
LK	Air damper
LP	Air pressure switch
LR	Load controller
m	Auxiliary changeover switch for the air damper's MIN position
M...	Fan or burner motor
NTC	Resistor with negative temperature coefficient
QRA...	UV detector
R	Control thermostat or pressurestat
RAR9...	Silicon photocell detector
SA	Actuator of air damper
SB	Safety limit thermostat
Si	External fuse
SM	Synchronous motor of sequence switch
v	In the actuator: Auxiliary changeover switch for release of fuel as a function of the air damper position
V	Flame signal amplifier
W	Limit thermostat or pressure switch
z	In the actuator: End switch for the air damper's fully closed position
Z	Ignition transformer
ZBV	Pilot valve
•	Valid for expanding flame burners
••	Valid for interrupted pilot burners with a pilot burner which is shut down after the main burner has ignited
A	Startup
B	Operating position
C	Controlled shutdown
D	End of control sequence
	Control signals delivered by the burner control
	Permissible input signals
	Required input signals:
	If these signals are not present at the points in time marked by symbols or during the shaded periods of time, the burner control will interrupt the startup sequence or initiate lockout

Lockout indication positions when there is no input signal (see *Control sequence in the event of faults*):

◀	No start
▲	Abortion of startup sequence
▼	Abortion of startup sequence
■	Lockout (fault in the flame supervision circuit)
1	Lockout (no flame)
2	Lockout (no flame)
P	Lockout (no air pressure)

## Legend (cont'd)

---

### Time table

t1	Prepurge time with air damper fully open
TSA	Safety time or first safety time with burners using a pilot burner
TSA'	Safety time or first safety time with burners using a pilot burner
t3	Preignition time
t3'	Preignition time
t3n	Postignition time (ignition transformer connected to terminal 15)
t4	Interval between the start of safety time (TSA/TSA') to the valve connected to terminal 19
t4'	Interval from the start of safety time (TSA/TSA') to the release of the valve connected to terminal 19
t5	Interval from the end of interval (t4/t4') to the release of the load controller or valve at terminal 20
t6	Postpurge time (identical with the permissible afterburn time (t13))
t7	Switch-on delay for fan motor M2
t8	Duration of startup sequence excluding running time (t11/t12)
t9	Second safety time with burners using a pilot burner
t10	Interval from the start to the beginning of the air pressure check
t11	Running time of air damper into the fully open position
t12	Running time of air damper into the low-fire position
t13	Permissible afterburn time
t16	Interval from the start to the OPEN command for the air damper
t20	Interval to the self-shutdown of the sequence switch
max.	Safety time in the event of loss of flame during operation
*	Times safety time (TSA'), long preignition time (t3') and interval (t4') are only programmed by burner controls LGK16.335... and LGK16.635...

Connection diagrams

LGK16...

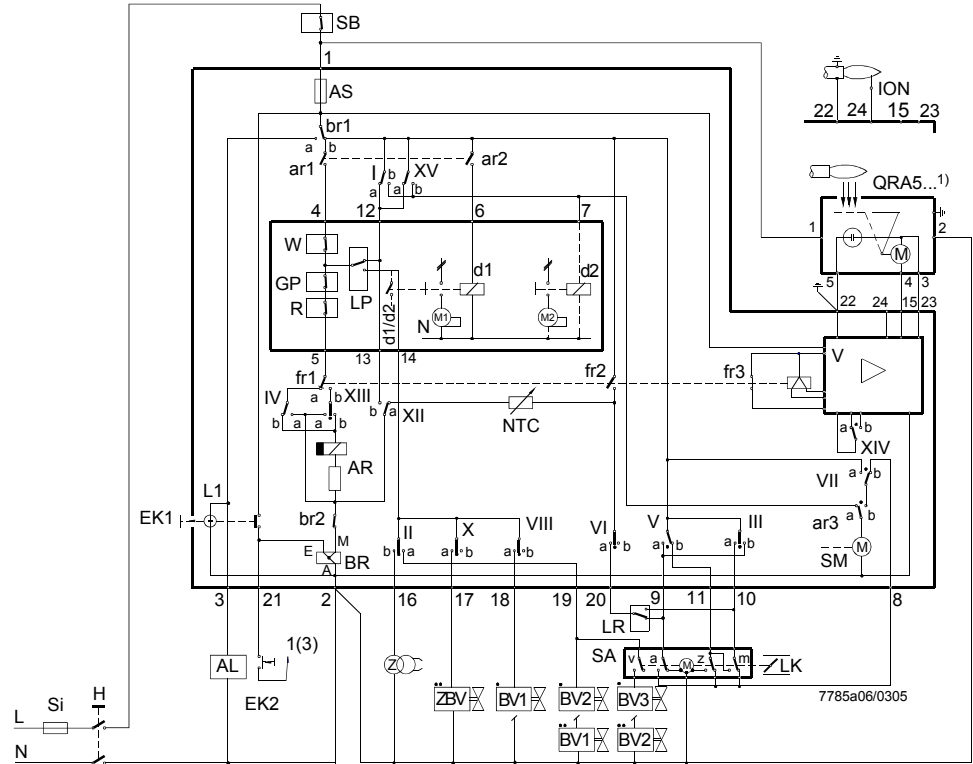

**Caution!**  
Do not press lockout reset button (EK...) for more than 10 seconds!

1) When used in connection with QRA53.../QRA55..., earthing of terminal 22 is mandatory!

LOK16...

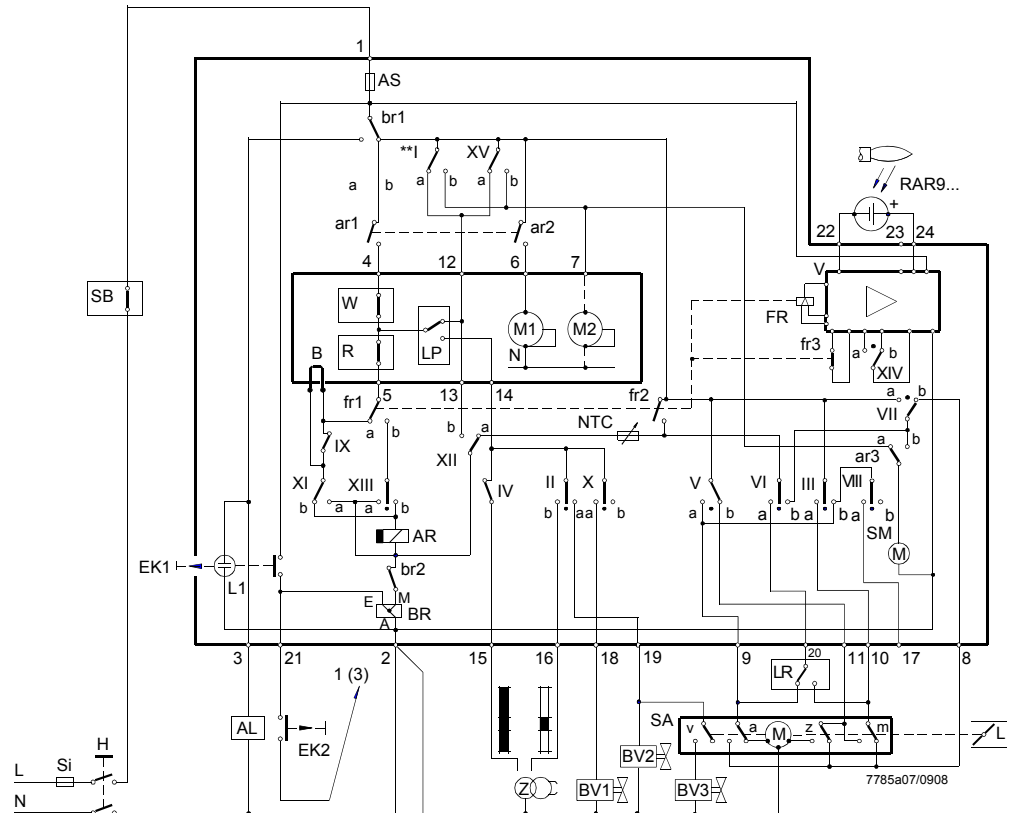

**Caution!**  
Do not press lockout reset button (EK...) for more than 10 seconds!

**Program sequence**

LGK16...

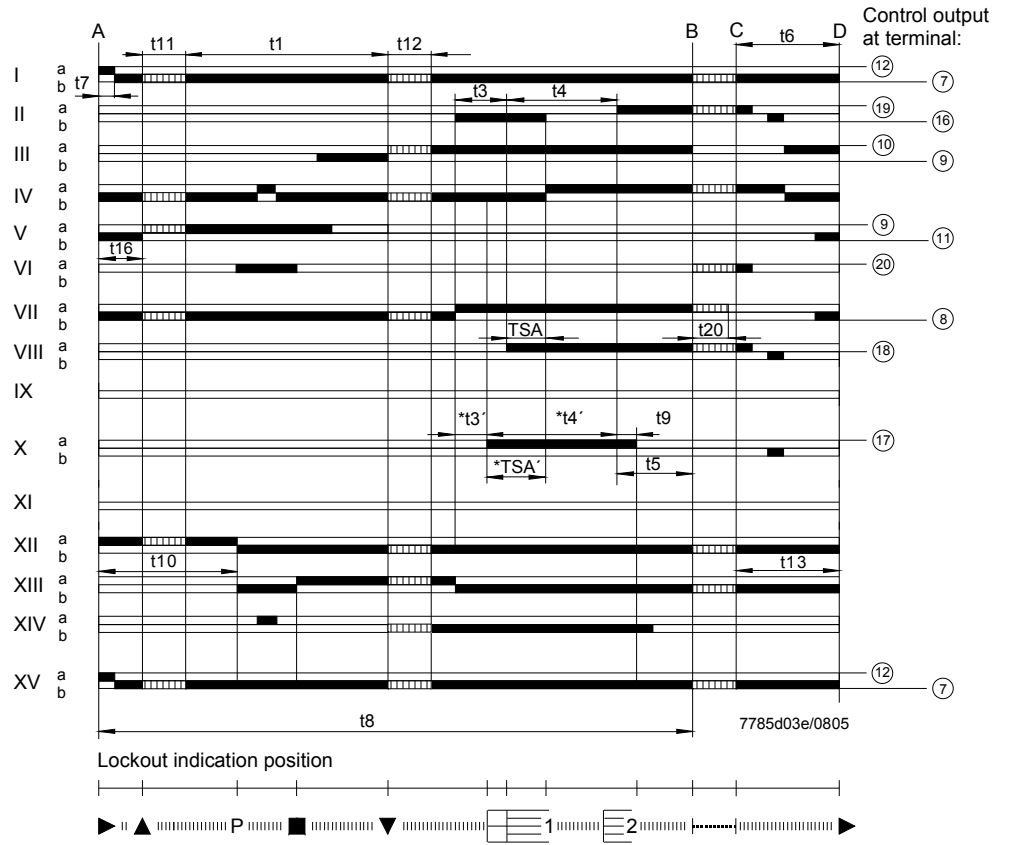

\* Times safety time (TSA'), long preignition time (t3') and interval (t4') are only programmed by burner controls LGK16.335... and LGK16.635...

LOK16...

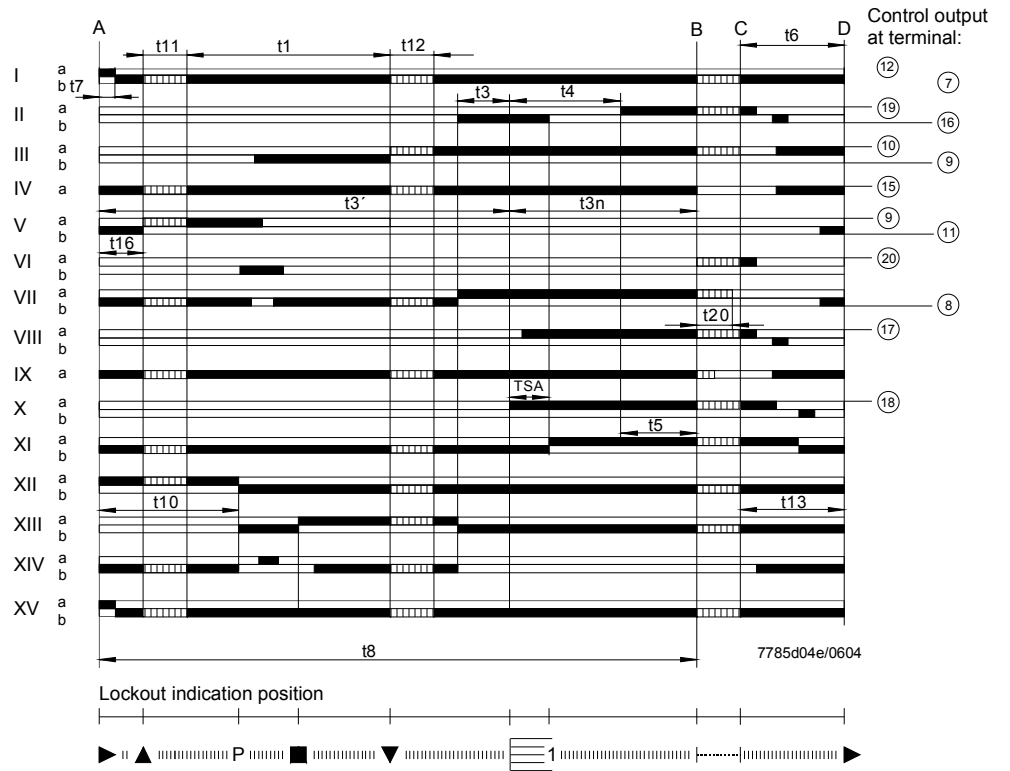

**Connection examples**

LGK16...

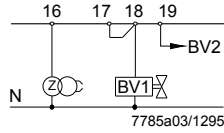

Doubling of safety time with expanding flame burners when using burner control **LGK16.335...** or **LGK16.635...**

By connecting terminals 17 and 18, the safety time is doubled and the preignition time reduced by 50%. Before using this circuit, it must be ensured that the longer safety time is in compliance with national standards and regulations!

LOK16...

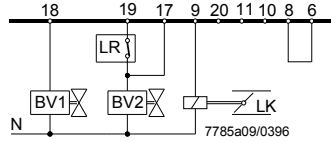

Control of the actuator during operation by feeding control signals to terminal 17

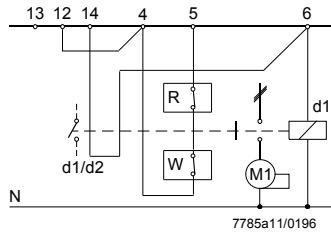

Wiring required for operation without air pressure supervision

If an auxiliary contact of the fan contactor is included in the circuit as shown in the diagram, ignition and fuel release are possible only when the contact is closed.

LOK16.../LGK16...

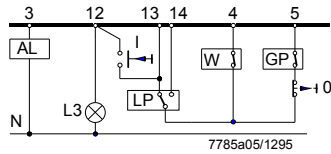

Semiautomatic startup

The burner is switched on manually by pressing button **I**. Then, the burner control programs the startup sequence and flame supervision.

The burner is switched off manually by pressing button **0**, or automatically by the limit thermostat or pressure switch (**W**), or by gas pressure switch (**GP**). Signal lamp (**L3**) indicates when the burner control is ready to be started; it extinguishes shortly after the burner is switched on.

For the other connections, see to the connection diagrams.

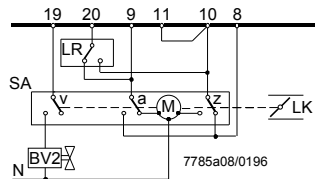

Connection of actuators without changeover end switch for the fully closed position.

Switch (**Z**) is set to low-fire

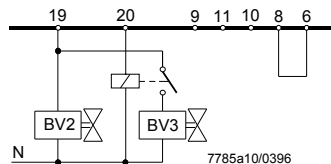

Control of a fuel valve by terminal 20 in the case of burners without air damper or with an air damper not controlled by the burner control.

The relay is not required if the valve connected to terminal 20 is hydraulically series-connected to a valve controlled by terminal 18 or 19. If no actuator is used, terminal 8 must be connected to terminal 6.

**Program sequence**

Expanding flame burners (burners without a pilot burner), controlled and supervised by **LOK16...** or **LGK16...**  
 Air damper in low-fire position during burner off times (min.).

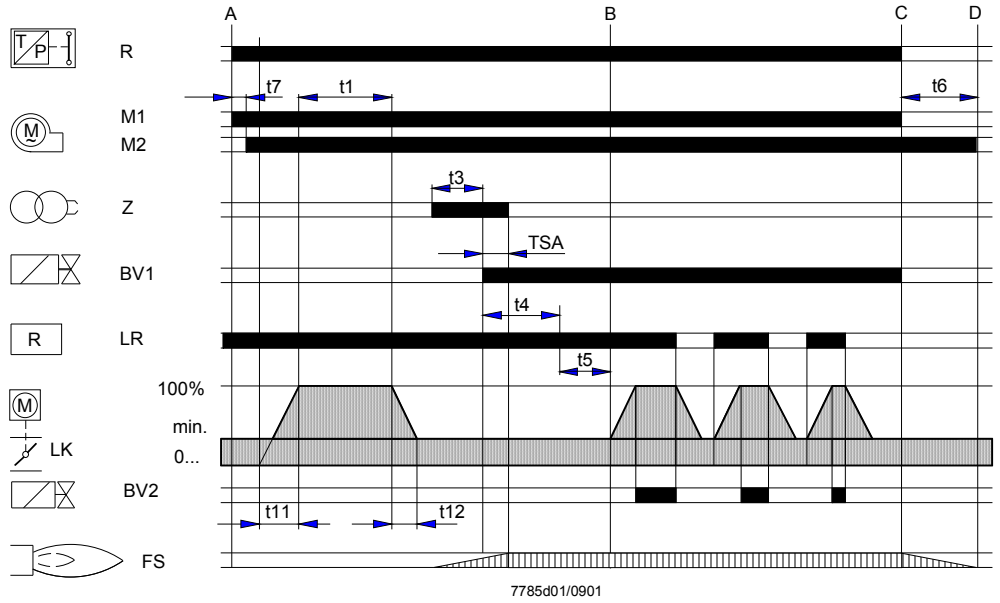

Interrupted pilot burners (burners with pilot burner), controlled and supervised by **LGK16.335** or **LGK16.635**, for example.  
 The other types of burner controls of the LGK16... range program the times safety time (TSA), pre-ignition time (t3), interval (t4) and second safety time (t9) for the pilot burner.

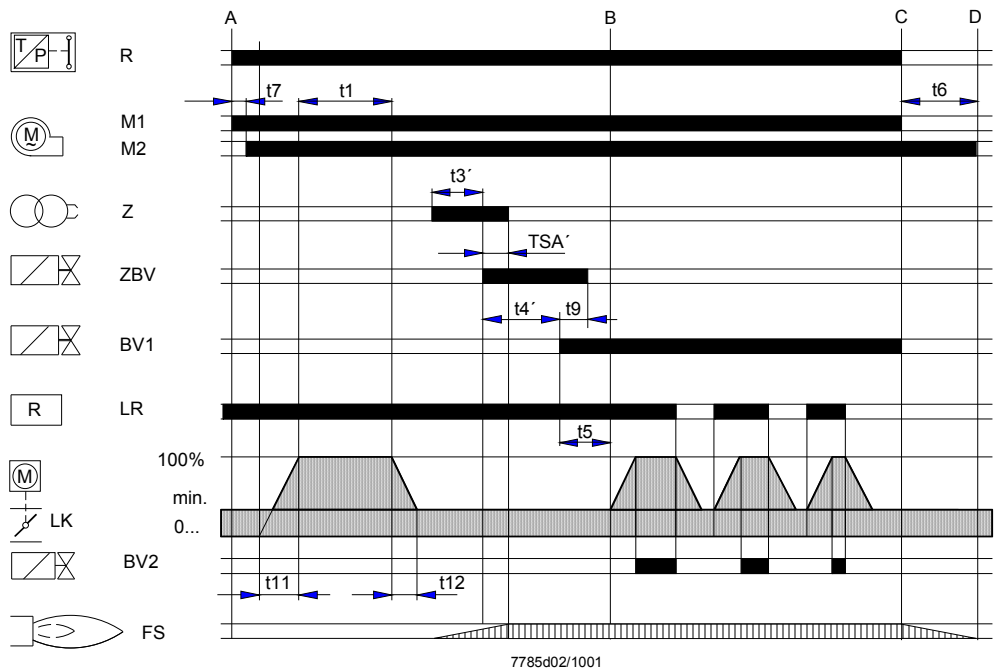

# Dimensions

Dimensions in mm

LOK16.../LGK16...



Plug-in base AGM17/AGM17.1

